

# ASSEMBLY INSTRUCTION FOR CHAIR

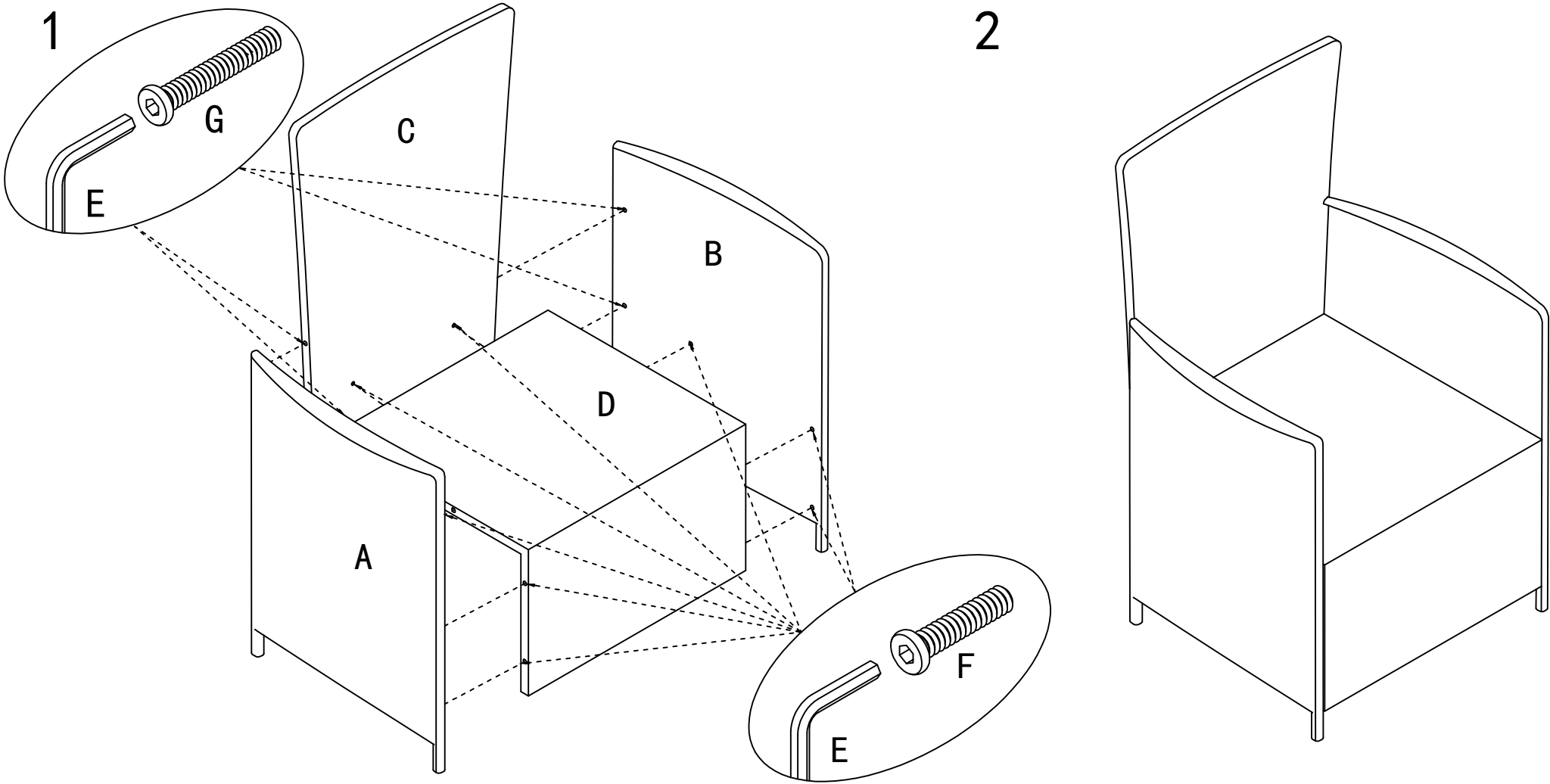

A

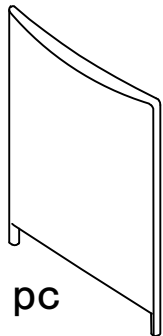

1 pc

B

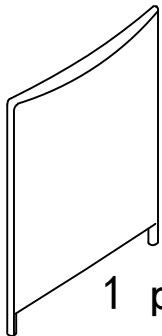

1 pc

C

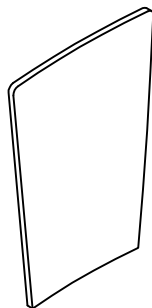

1 pc

D

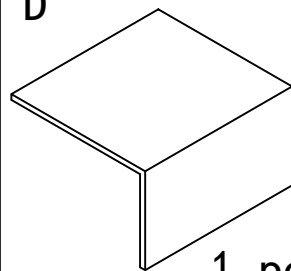

1 pc

E

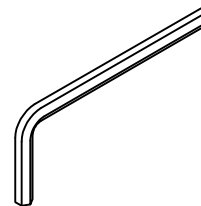

1 pc

F

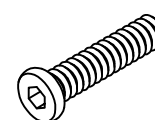

M6x35  
8 pcs

G

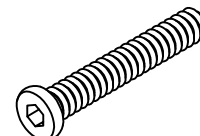

M6x40  
4 pcs

# ASSEMBLY INSTRUCTION FOR TABLE

