

F9702 TV STAND

ASSEMBLY INSTRUCTIONS

PART LIST



1. UPPER PANEL 1PC



2. UNDER PANEL 1PC

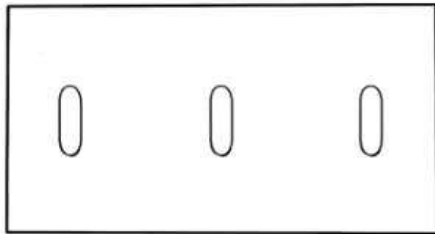

3. REAR PANEL 1PC

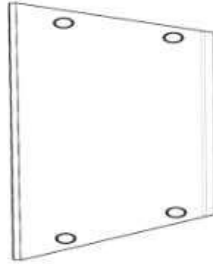

4. LEFT PANEL 1PC



5. RIGHT PANEL 1PC

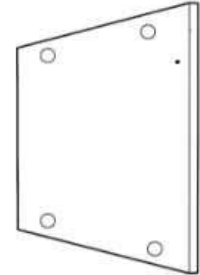

6. CENTER LEFT PANEL 1PC

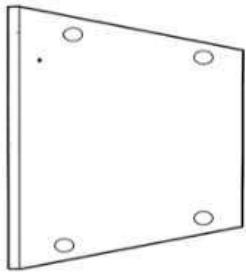

7. CENTER RIGHT PANEL 1PC



8. HORIZONTAL PANEL 1PC

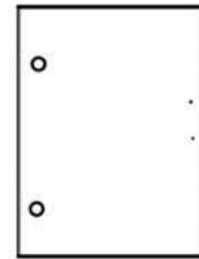

9. FRONT DOOR PANEL 2PCS

HARDWARE LIST

A  X 20 SETS

B  40MM X 8 PCS

C  X 2 PCS

D  X 4 PCS

E  X 4 PCS

F  15MM X 24 PCS

G  X 8 PCS

H  X 2 PCS

I  20MM X 4 PCS

COMPONENT DESCRIPTION

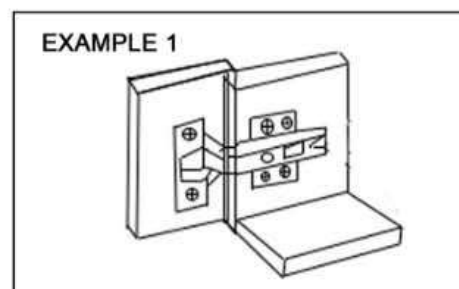
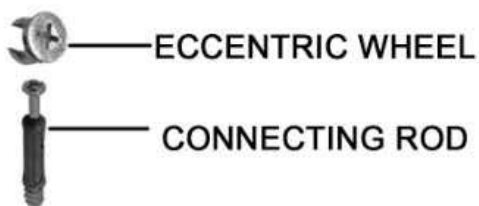

STEP 1

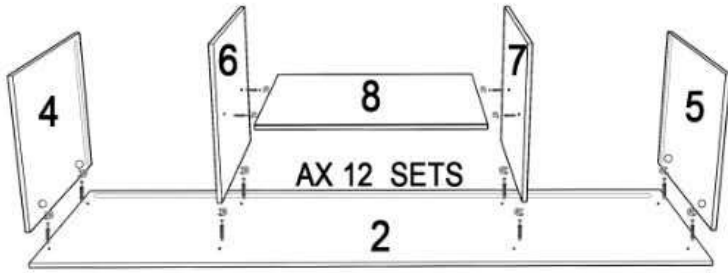

FIRST CONNECT CENTER LEFT PANEL(6), CENTER RIGHT PANEL(7), HORIZONTAL PANEL(8) TOGETHER, THEN INSTALL LEFT PANEL(4), RIGHT PANEL(5), CENTER LEFT PANEL(6), CENTER RIGHT PANEL(7) ON UNDER PANEL(2), USING HARDWARE A(X12 SETS).

STEP 2

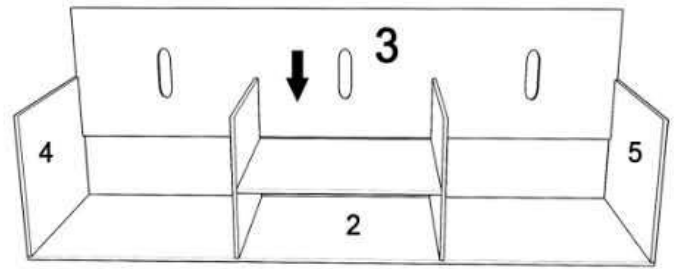

INSERT REAR PANE(3) INTO THE FRAME ASSEMBLED IN STEP 1.

STEP 3

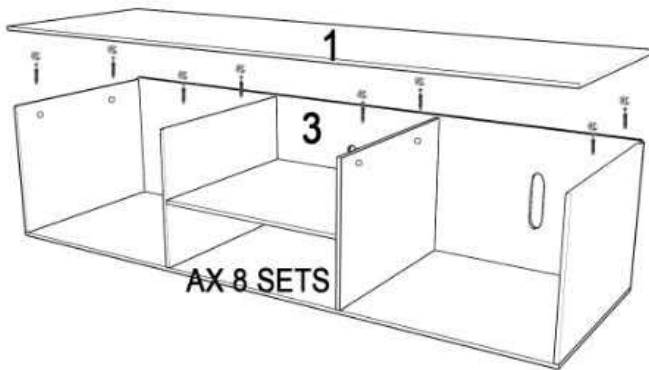

INSTALL UPPER PANEL(1) ON THE FRAME ASSEMBLED IN STEP 2. USE HARDWARE A(X8SETS).

STEP 4

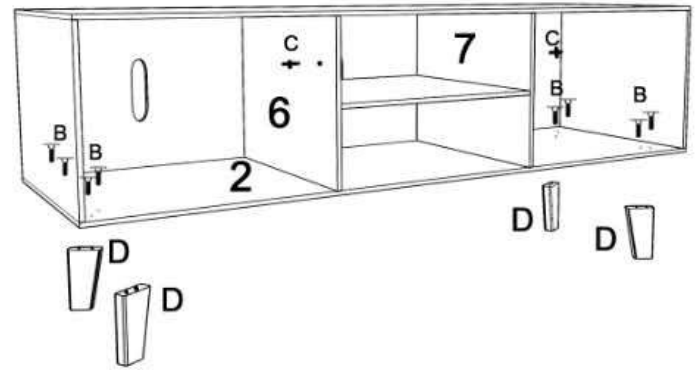

USE HARDWARE B(X8PCS) TO MOUNT D(X4PCS) TO UNDER PANEL(2),AS SHOWN IN THE FIGURE, INSERT C(X2PCS) ON CENTER LEFT PANEL(6), CENTER RIGHT PANEL(7) RESPECTIVELY.

STEP 5

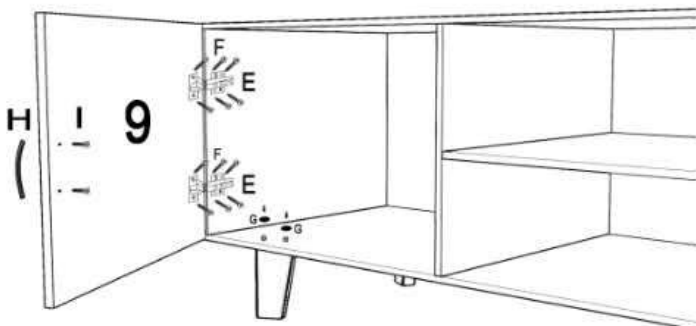

USE HARDWARE E(X2 PCS) TO INSTALL FRONT DOOR PANEL (9) ON THE FRAME AND FIX IT WITH SCREWS F(X 12PCS). REFERENCE EXAMPLE 1 AS SHOWN, FILL THE HOLE LEFT BY THE LEG WITH G(X 8PCS). USE SCREW I (X2PCS) TO FIX H(X 1PC) TO FRONT DOOR PANEL(9).

REPEAT THIS STEP TO INSTALL ANOTHER DOOR

STEP 6

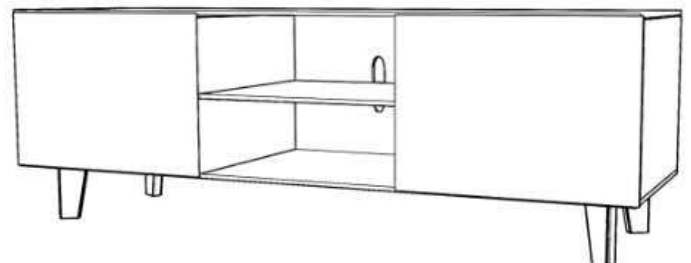

INSTALLATION COMPLETED